

**PRODUCTOS
DESTACADOS**

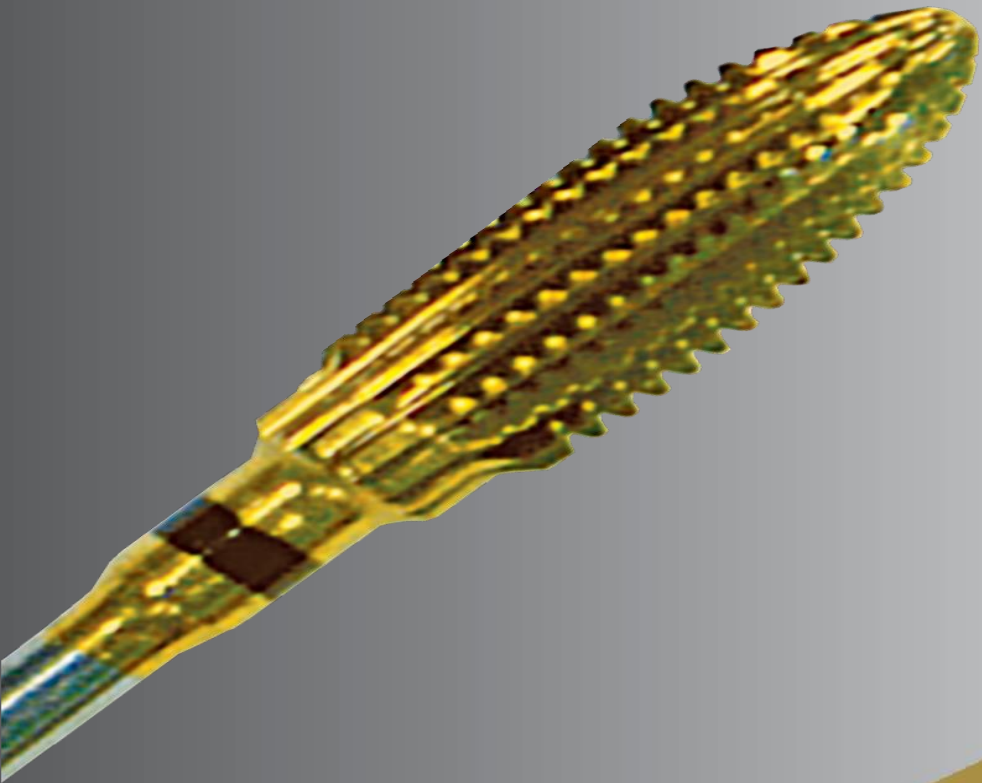

**DENTAL ARROYO
SELECDENT**





En dental arroyo, nos avalan más de 45 años de experiencia, sabemos cuáles son las necesidades de nuestros clientes, y para ello hemos preparado esta selección de productos dentales (seleccion), que le pueden ser de gran ayuda en su trabajo.

Somos asesores especialistas en productos odontológicos, nuestra labor es darles un trato personalizado, y escuchar sus opiniones, que es lo que nos hace mejorar, aprendiendo día a día para llevar a su clínica el producto que necesita en cada momento.

Adelaido Arroyo Lanchas



Ofertas válidas hasta el
5 de septiembre, salvo
cambios imprevistos del
fabricante

Otros productos
consultar

Whatsapp 676 17 04 78



OFERTA SELECCIÓN DE FRESAS PARA TALLADO, CIRCONIO Y CERÁMICA



10 Fresas de tallado a elegir

~~P.V.P. 107 €~~

**OFERTA 90 € + FRESERO
GRATIS**



RETOCAR CERÁMICA Y ZIRCONIO



Aguantan el triple de revoluciones **12.000 R.P.M.**

Estética como el laboratorio

Pulir amalgamas y dar forma a composites

Duran más

Mejor con pasta diamantada

12.000 R.P.M.

PR-10

PU-11

BR-12



Rebajar sin riesgo

Pulir

Brillo de espejo

15.000 R.P.M.



10.000 R.P.M.



5.000 R.P.M.



PR-332

PU-332

BR-332

~~P.V.P 81€~~

OFERTA Kit 6 uni. 73 €+

FRESERO GRATIS

(para evitar usos indebidos)





LÁMPARA POLIMERIZACIÓN

Mayor superficie de polimerización
no contrae el composite
y evita microfisuras

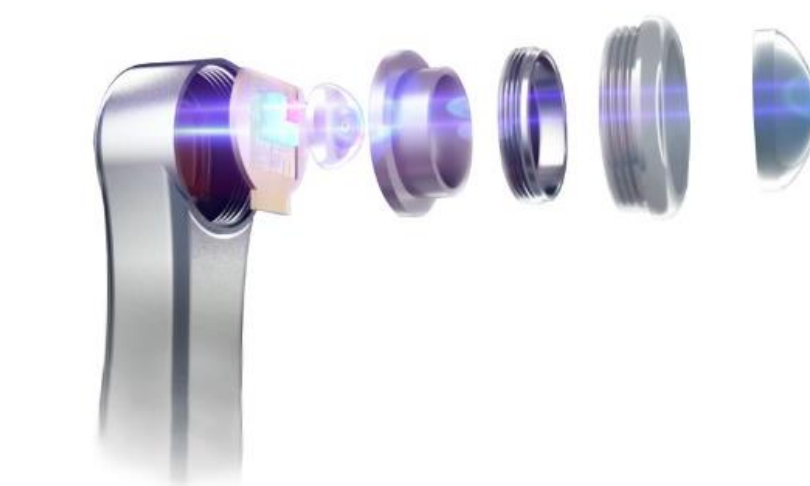

Polimeriza:
en 1 seg, 2 mm
en 3 seg, 6 mm

Cabeza metálica más resistente,
no se rompe

Inalámbrica, ergonómica y ligera

156 €

**Con 100
fundas
de protección
gratis**

**i-led
MAX**





PUNTAS ULTRASONIDO

Tipo Ems y Satelec

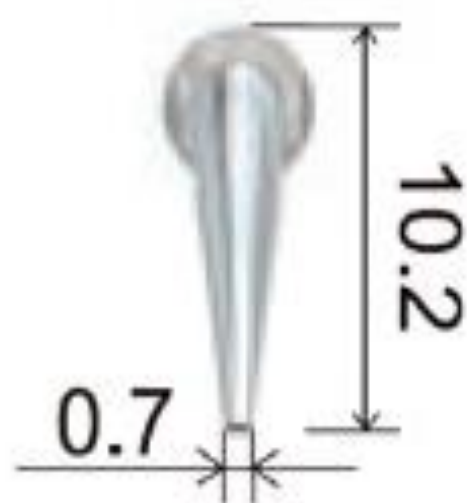
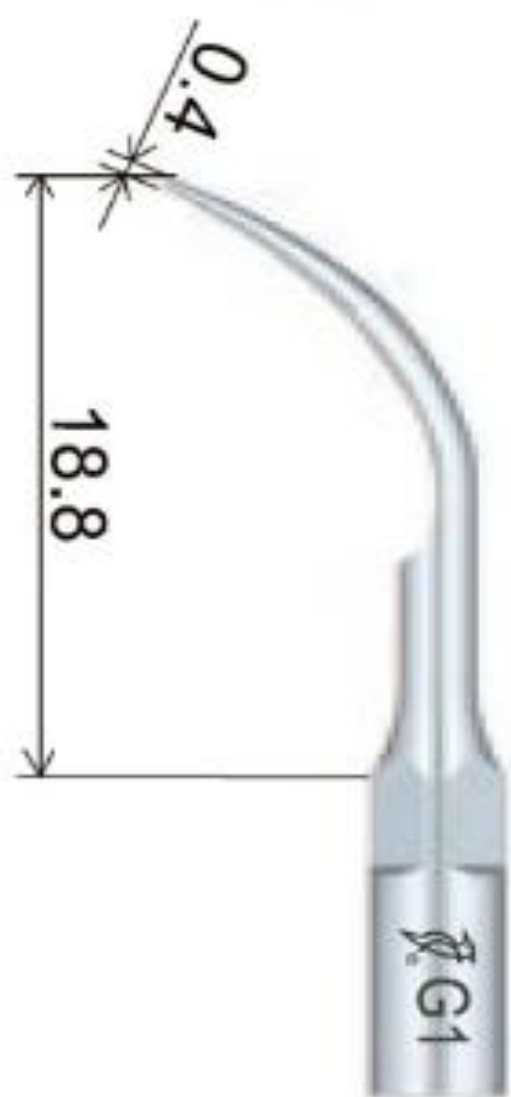

Sat 1 profilaxis
Ems 1 profilaxis

Sat 5 perio
Ems 5 perio

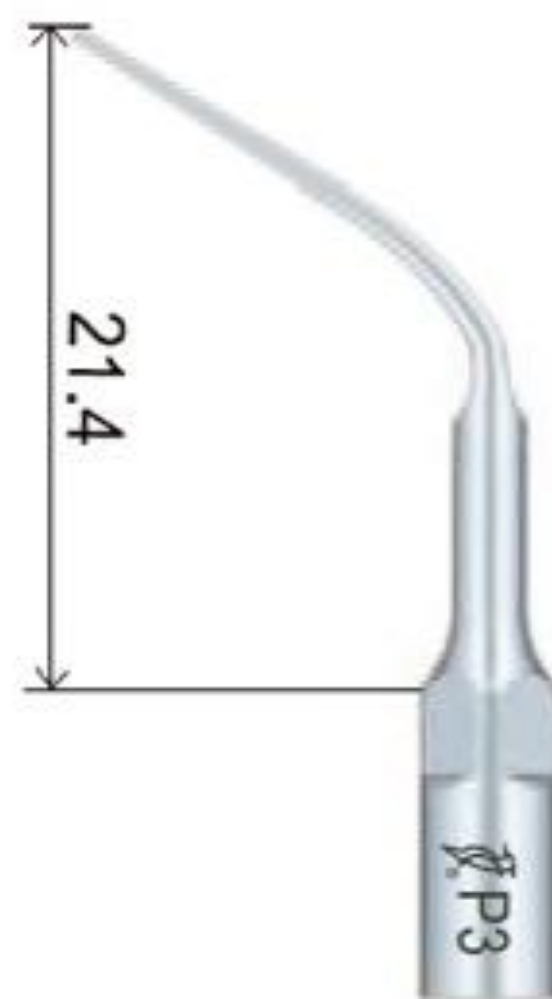

1 a 42 €

3 a 37 € / una

6 a 28 € / una



SEPTO CONTACT FORMADOR DE PUNTOS CONTACTO



Juego con 2 instrumentos Rf. 10363T



**Ahorra
segundas
visitas**



2 tamaños

Empaquetamientos

Crea el punto de contacto en caries proximales



**Fotopolimerización
a través del
instrumento**

Presionar el punto de contacto por mesial
o distal y fotopolimerizar al tiempo

54 €



SEPTO COMPO SHAPE

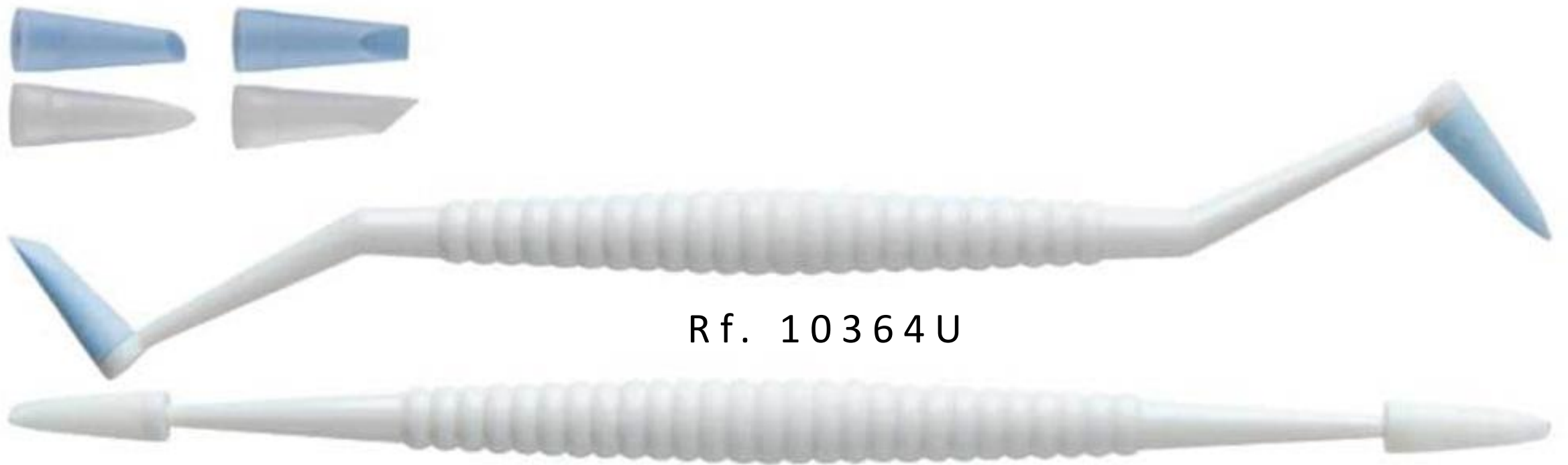

Rf. 10364U

Puntas de silicona para modelar obturaciones
2 instrumentos recto y acodado + 8 puntas de
silicona (suáves/duras).



4 formas diferentes intercambiables

No se adhiere al composite

Ahorra tiempo

Esterilizables en autoclave

54 €



SEPTO MATRIX

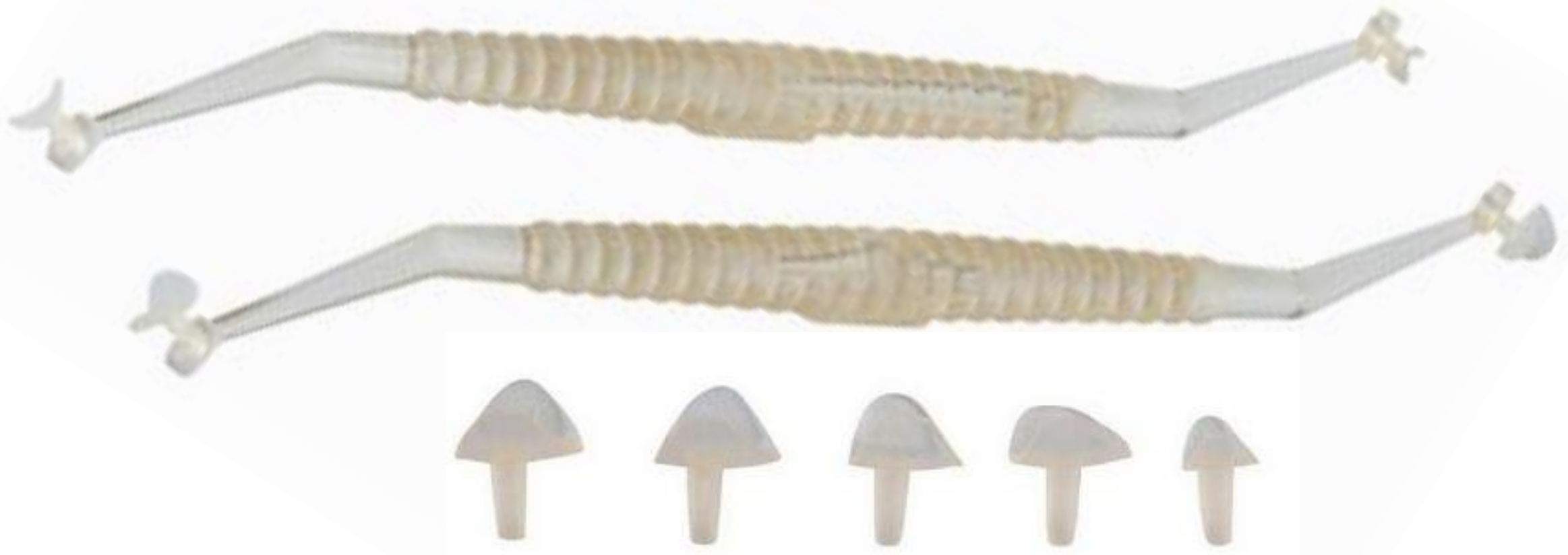

Rf. 10356M

2 instrumentos + 10 matrices surtidas(2 de cada una)



54 €

No se adhiere al composite
Flexible, adaptable y anatómica
Fotopolimeriza a través de la matriz
Ahorra pulido y tiempo



KIT OBTURACIONES



SEPTO CONTACT



SEPTO MATRIX

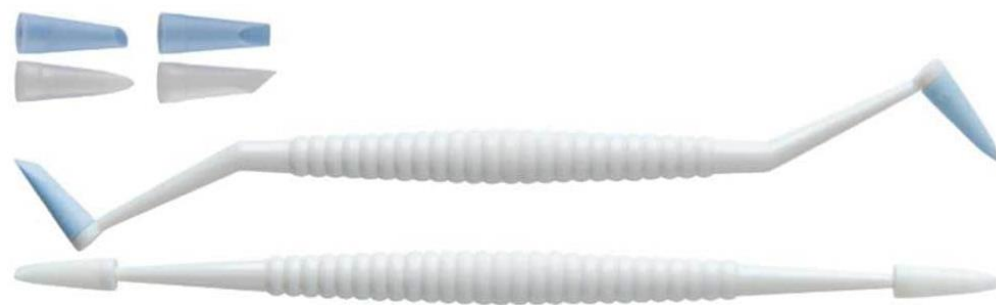

SEPTO COMPO

~~PVP 162~~

**OFERTA 3KITS A
ELEGIR 139 €
MAS KIT
MATRICES TORM
GRATIS**



18 MATRICES + PINZA



KIT EXPLORACIÓN



1 a 24,50 €
5 a 18 €/Uni
10 a 14 €/Uni



OFERTA INSTRUMENTAL OBTURACIÓN

Combinando obturación,
exploración o cirugía

4 a 10,50 €

8 a 6,50 €



Loseta de vidrio RF-09991



Espátula doble de mezcla Eco-1432



Espátula doble titanio antiadherente Eco-1438-T



Espátula bola Eco-1579

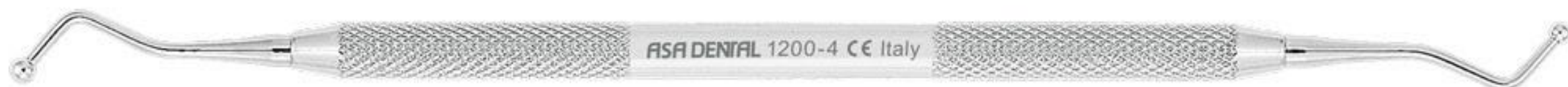

Atacador doble bola Eco-1457 (pequeño),
Eco-1458 (mediano), Eco-1459 (grande)





OFERTA INSTRUMENTAL EXPLORACIÓN

Combinando obturación,
exploración o cirugía

4 a 10,50 €
8 a 6,50 €

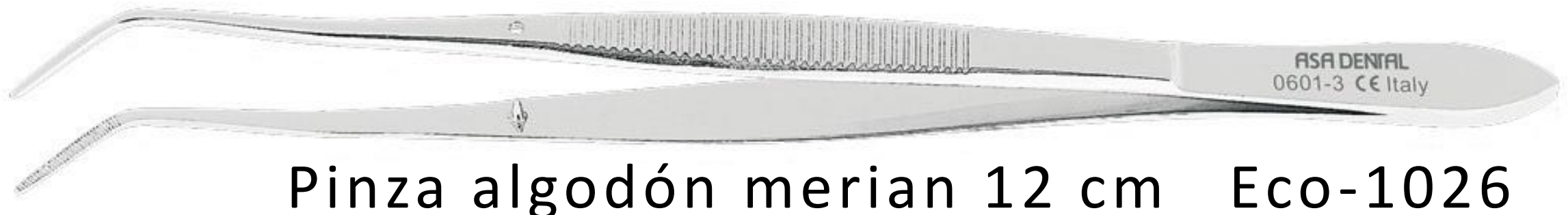

Pinza algodón merian 12 cm Eco-1026



Sonda explorador doble Eco-1093



Cucharilla pequeña diámetro 1,25 mm eco 1192

Cucharilla mediana diámetro 1,50 mm Eco 1193

Cucharilla grande diámetro 2 mm Eco 1194



Sonda perio redondeada, no daña como la bola
(3-6-8-11mm) Eco 1115

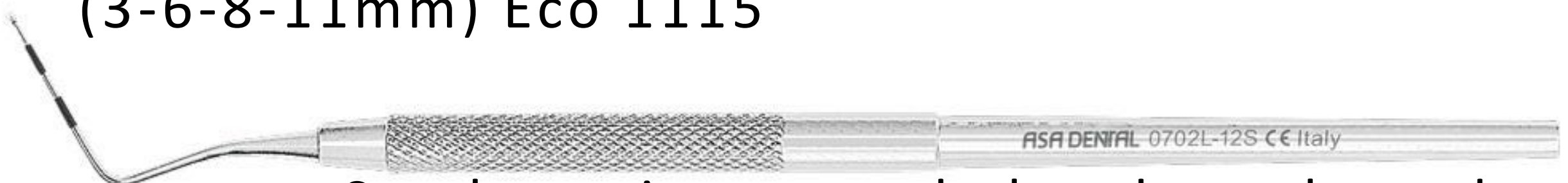

Sonda perio o.m.s. de bandas coloreadas
Eco 1117



OFERTA INSTRUMENTAL CIRUGÍA

Combinando obturación,
exploración o cirugía

4 a 10,50 €

8 a 6,50 €

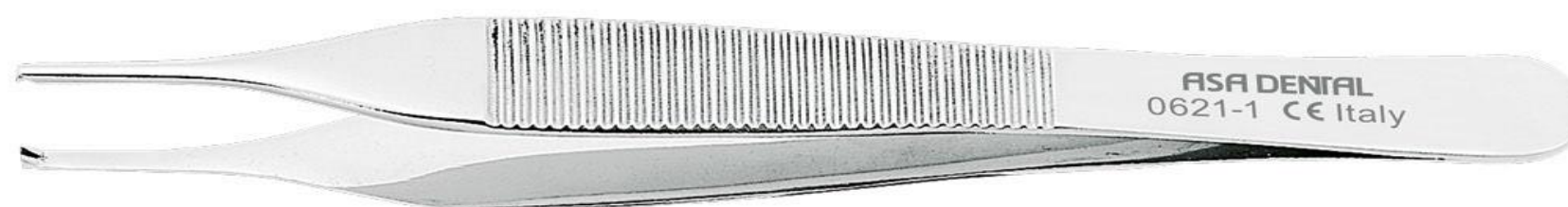

Pinza cirugía adson con diente Eco-713

Pinza cirugía adson sin dientes Eco-712



Mango bisturí no. 3 Eco - 578

Tijera recta 12 cm eco -530



Tijera curva 12 cm Eco -531



Mango con espejo Eco-1222

MATRICES TORM

Anatómicas

• *No deja escalones, como las matrices rectas*



Fácil colocación



Punto de contacto óptimo



Ideal extremos libres



Distal



Mesial

Cómodo, económico, fácil, ahorro de tiempo



Oferta kit 54 €

REF	REPOSICIONES	PVP €
1003	1 CLIP	11
1311	12 MATRICES PEQ.	16
1312	12 MATRICES MED.	16
1313	12 MATRICES GRD.	16

**48 unidades surtidas
(de 12 en 12)
56 €**



GEL GELCIDE ESSENTIALS

**Antiséptico, adhesivo (12-15 días), sin efectos secundarios.
Cicatrizante, antiinflamatorio, analgésico,
desensibilizante dentinario**

Sin alergias - sin tinciones - sin candidiasis ni diarreas

**Mata incluso anaeróbicos por asfixia.
No depende del mal uso del paciente**



Rellena y sella en 1'

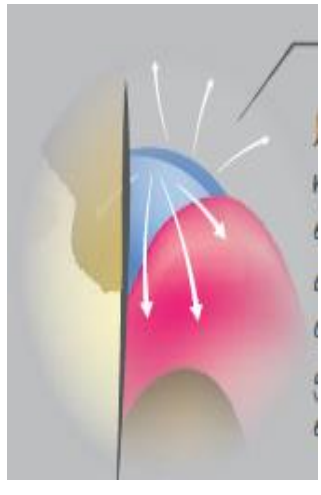

Acción continua sólo en la zona

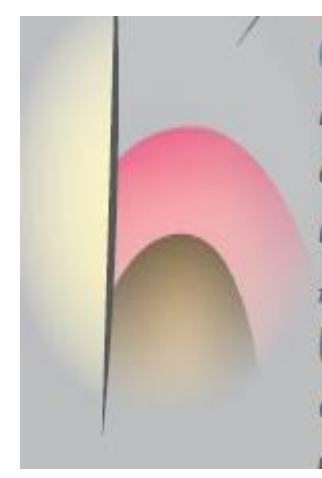

Reduce 90% de bolsa en 1 aplicación



Extracciones



Alveolitis



Suturas

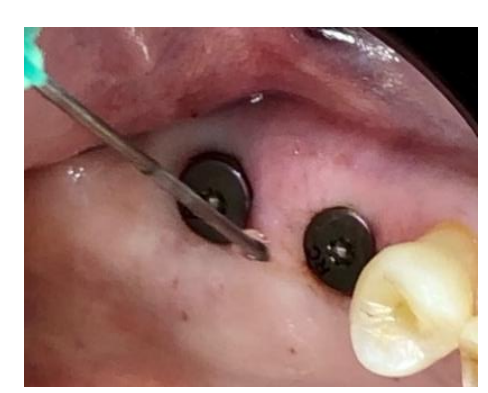

Sellado de implantes

**No irrita, no duele y no deja residuos
Ideal embarazadas**

Más info.:
https://arroyoselecdent.com/informacion_producto

Gel 89 €

Barniz 49 €



Rf- ITD021IA



SEPTOCONE

Todas las **extracciones dentales** deben ir seguidas de **un tratamiento adecuado del alveolo post extracción**

Origen equino

Ahorra hueso

Sin tratamiento: **pérdida ósea**

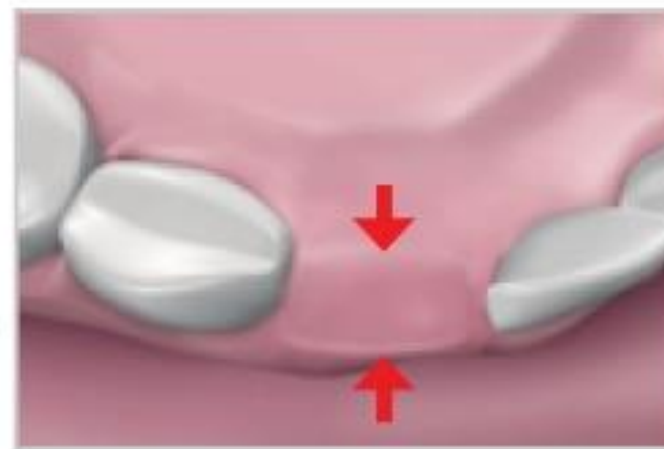
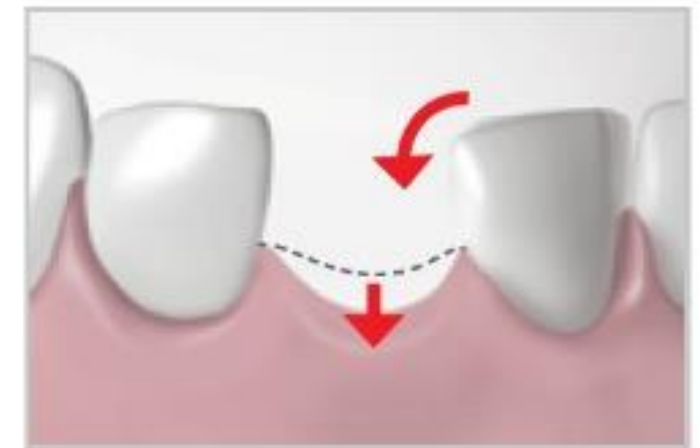
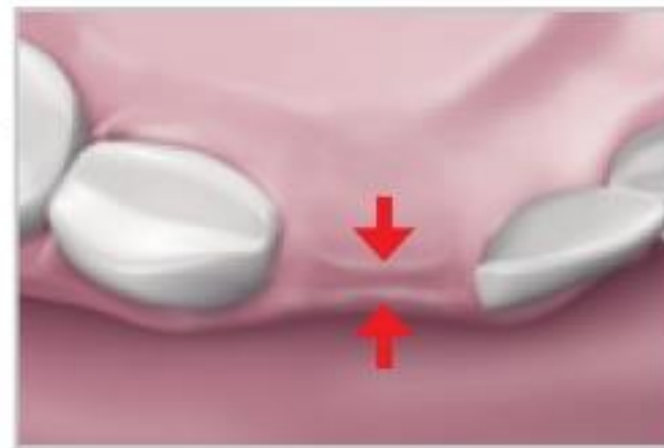

Con tratamiento: **mejora de la curación**

Cono de colágeno de Alta densidad

reabsorbible en 3 - 4 meses

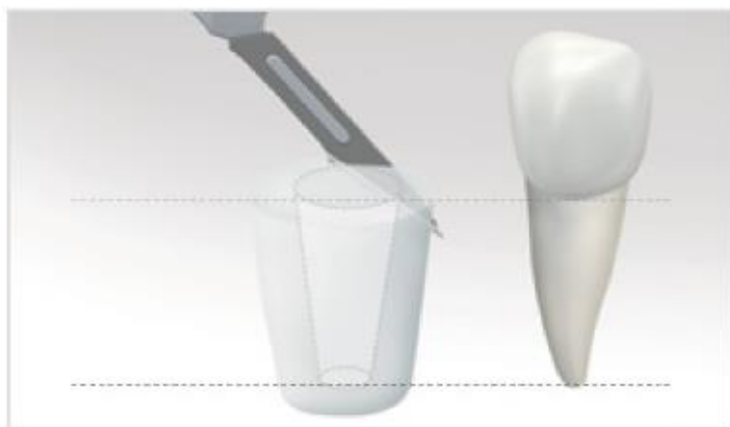

Si es necesario, se puede ajustar el tamaño del cono.



Alveolo post extracción.



Tratamiento del alveolo post extracción: Aplicación de SeptoCone.

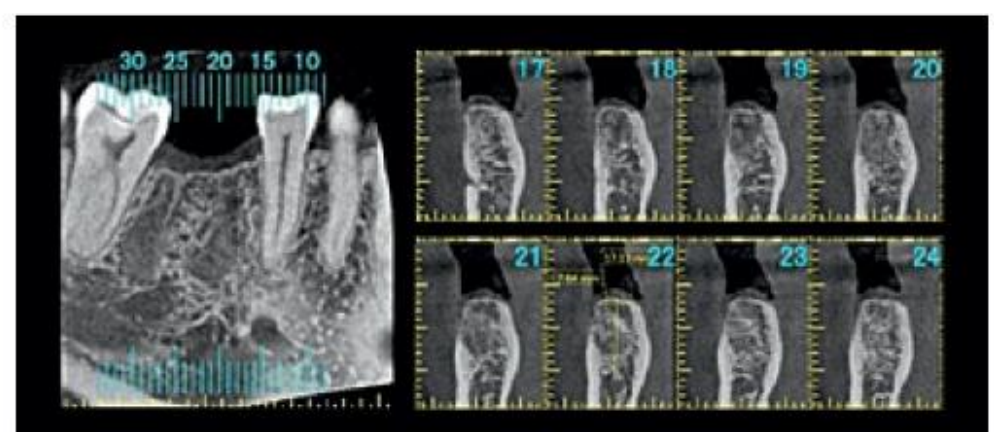

5 meses de seguimiento: la curación del hueso es visible en el TAC (tomografía computarizada de haz cónico [CBCT dental]).

10 unidades **134 €**



NANOSYNT

Injerto óseo 100 % sintético



40% β -FOSFATO TRICÁLCICO Y
60% DE HIDROXIAPATITA

No tóxico, radiopaco,
muy biocompatible

Tubos de 0,27 cc
**No desperdicia
material**

**Evita el 20 % de
mermas
y segundas cirugías**



**Vasculariza más
y regenera
el hueso mejor**

	PVP	OFERTA
NANOSYNT 200 a 500 um 0,54 cc (2 tubos)	64,95 €	44,97 €
NANOSYNT 500 a 1000 um 0,54 cc (2 tubos)	64,95 €	44,97 €
NANOSYNT 200 a 500 um 1,08 cc (4 tubos)	111,59 €	78,11 €
NANOSYNT 500 a 1000 um 1,08 cc (4 tubos)	111,59 €	78,11 €

19,53 € TUBITO



- **Poner sobre cualquier hueso, bovino, porcino, equino, autólogo**
- Defectos óseos intraorales y maxilofaciales pequeños o medianos con al menos 3 paredes de soporte restantes.
- Reconstrucción / relleno alveolar de 1 o varios elementos (por ejemplo, después de la extracción).
- Reconstrucción (horizontal y vertical) en casos de defecto óseo en la cresta alveolar.
 - Elevación sinusal.
 - Tratamiento regenerativo periodontal.
- Relleno de defectos óseos después de la apicectomía, extirpación de quistes óseos y osteotomía correctiva.
 - Tratamiento regenerativo periimplante.

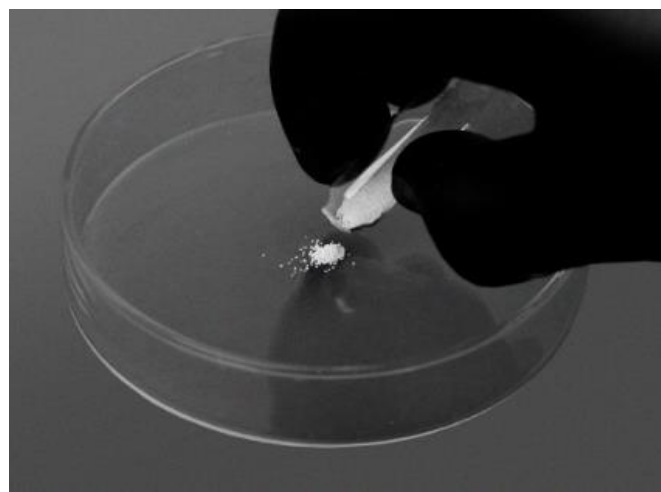

Mezclar con suero, sangre o hueso autógeno

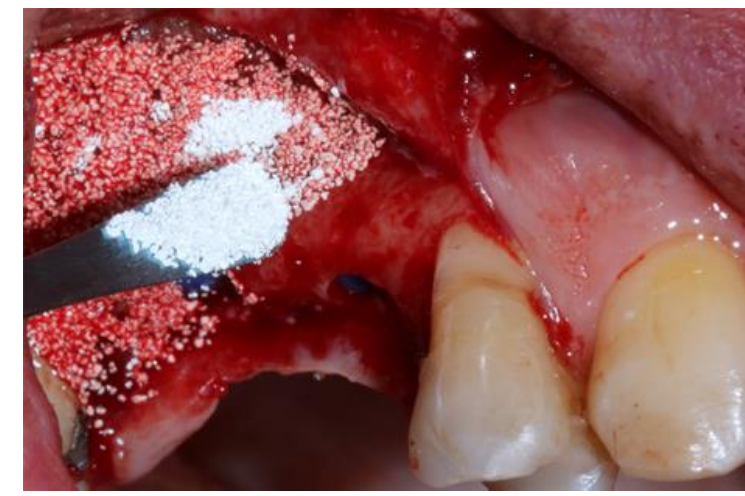
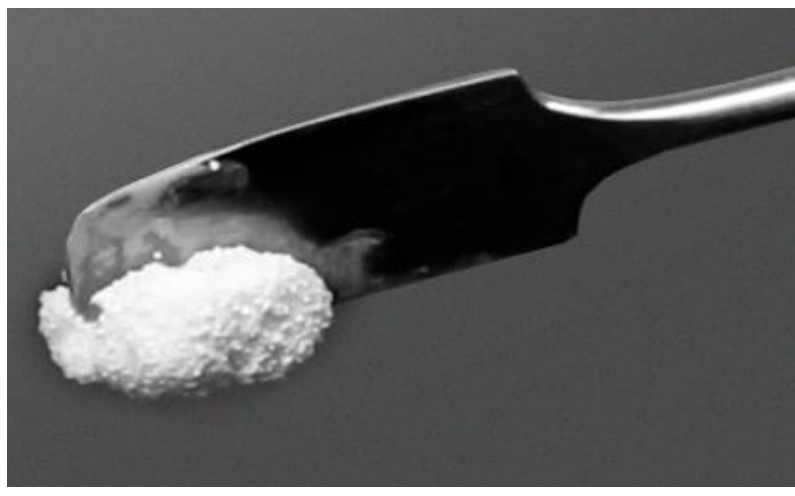

**Fácil transporte hasta la zona,
se adhiere a la espátula**



PREVDENT DESENSIDENT

Desensibilizante y remineralización

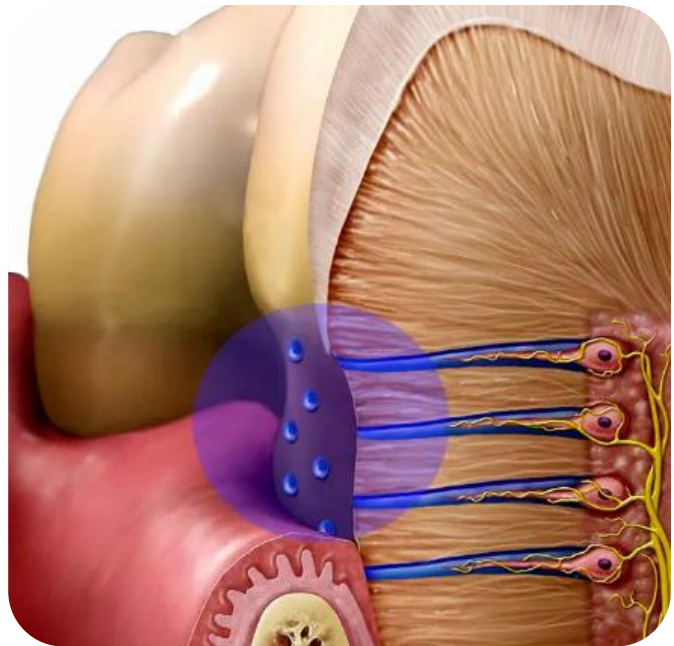

KIT
28€

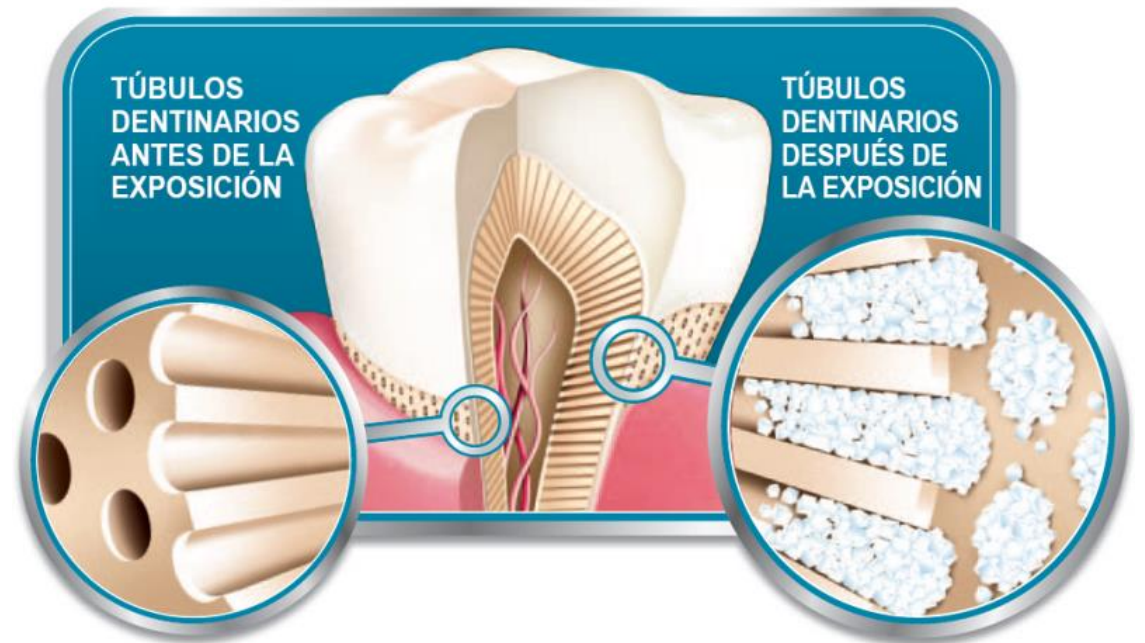

Cavidades



Tallados



Kit inicio paciente

- nanohidroxiapatita suero dental (30ml)
- 4 esponjitas de 1 ml de nanohidroxiapatita

PREVDENT ESPONJITAS HIDROXIAPATITA

Es la versión más pura de hidroxiapatita
permite remineralizar el esmalte dental
a nivel nanoscópico



Aplicar una cada dos días



10 Unidades **35 €**
(3,50 € esponja)

20 Unidades **64 €**
(3,2 € esponja)

50 Unidades **139 €**
(2,78€ esponja)

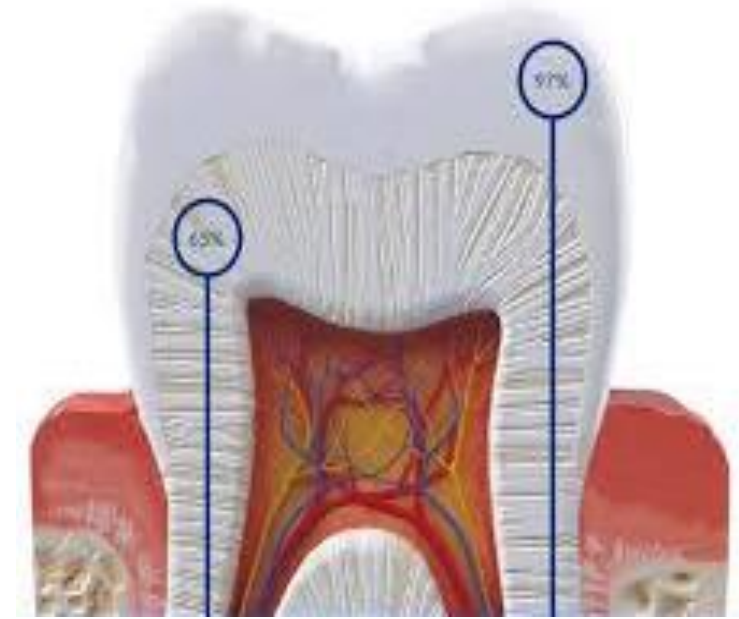

Hidroxiapatita:
esmalte 97%,
dentina 65%

POST-TRATAMIENTO Y MANTENIMIENTO

Prevdent pasta dental de nanohidroxiapatita



- ✓ **Combinación única de nano-hidroxiapatita y xilitol**
- ✓ **La bacteria responsable de causar caries, no puede digerir el xilitol y muere**
- ✓ **Dificulta la aparición de placa bacteriana**

10,70€

Este producto no existe ni en farmacias
ni en supermercados, debe
proporcionarlo la clínica

WHITENESS HP AUTOMIX

35 % peróxido de hidrógeno (uso clínico)

Kit 5 g de HP AUTOMIX

- 1 jeringa de whiteness hp automix con 5g
- 5 puntas automezcla
- 1 jeringa de top dam con 2g.
- 1 frasco de solución neutralize con 2g (neutralizador de peróxido)



No cambia de color, mejor control

• **Bloquea el calor producido por las lámparas, reduciendo la sensibilidad**

• En caso de quemadura, descompone el hidrógeno evitando el daño en la encía

• Remineraliza, reduciendo sensibilidad

• **Dos pases de 15 minutos, o tres pases de 8 minutos,**

• **Aclarando entre pases**

• Pulir siempre después del blanqueamiento

Jeringa 2gr a 43,96 €

3 + 1 gratis

32 € paciente

Jeringa 5gr a 77,78 €

38€ paciente

3 + 1 gratis

28 € paciente



WHITENESS PERFECT

Peróxido de carbamida al 10 % y 16 % para
blanqueamiento en casa

Whiteness Perfect

¡En 2024 **no**
podría ser
diferente!

5X
GALARDONADO
MEJOR BLANQUEADOR
CASERO EN EEUU



Jeringa de 3 gramos

Dura entre 12 y 15 días

Uso durante la noche
ph neutro evita descalcificaciones

~~PVP 422,67 €~~

OFERTA 337,04 €

Kit 5 jeringas (15gr)
2 planchas férulas
+ portaférulas
+ puntas

62 €

1 jeringa 12,20€

**OFERTA 3 + 1
+ 1 Unique 2gr.
Gratis**



1 jeringa 9,15 €



Kit 50 jeringas
individuales de 3gr

Jeringa 6,74€



AQUAFLUOR

Barniz desensibilizante uso profesional



10 ml

- ✓ Efecto inmediato y a largo plazo, al sellar los microporos
- ✓ Después del blanqueamiento profesional. Evita incrustaciones de restos de café, vino, tabaco, etc, haciendo que dure más el blanqueamiento
- ✓ No amarillea los dientes
- ✓ Pueden comer al momento
- ✓ Sin disolventes, no agitarse
- ✓ Se seca con aire

1 a 59€

2 a 52,50€ uni

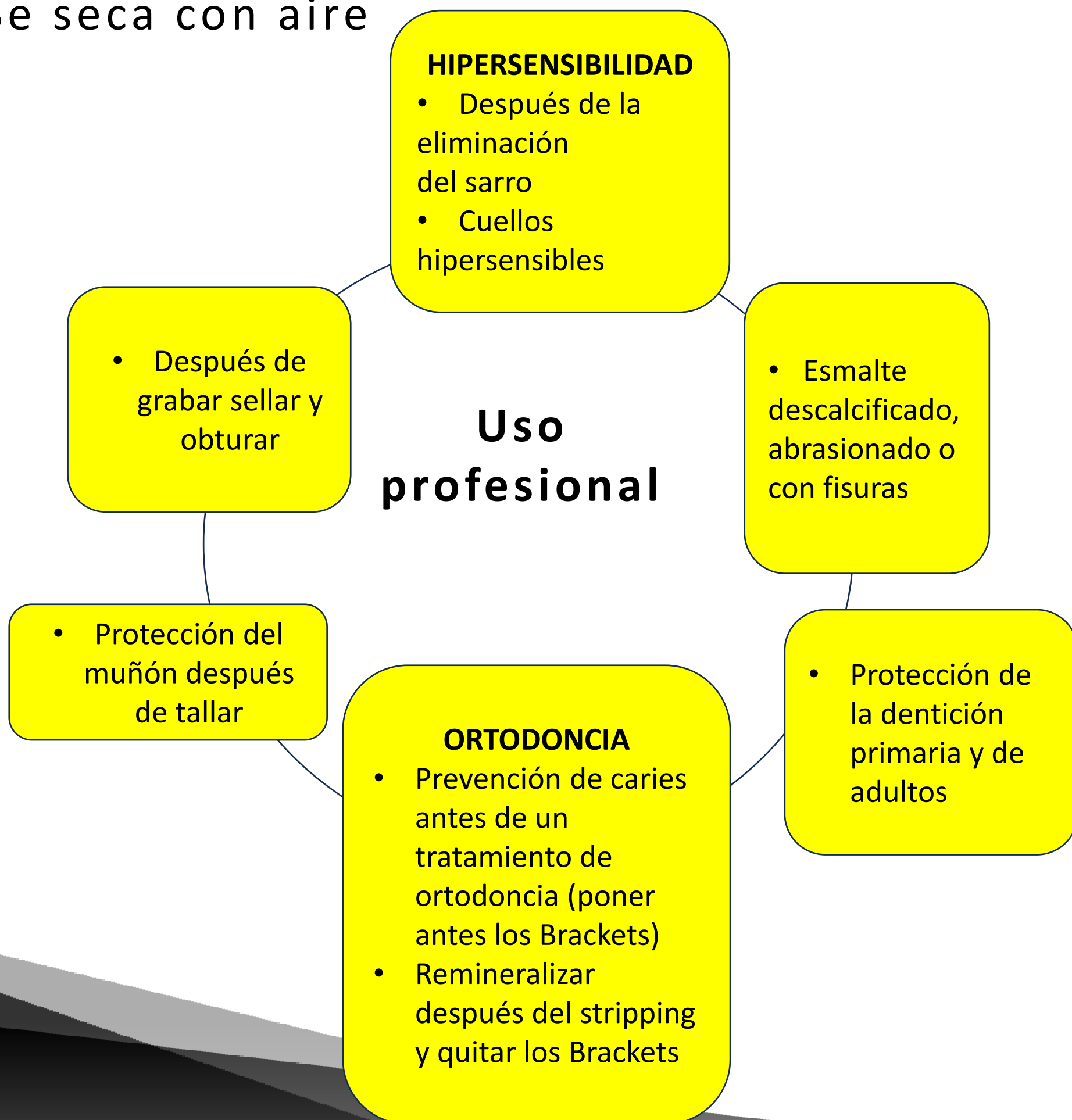



Cemento de resina definitivo universal

CRU SELECCION



AHORA



**Sin acido – sin adhesivo – sin coronas
altas – sin problemas de humedad –
sin bisfenol (Bis GMA)**

4 productos en 1

Cementa todos los materiales

Reconstruye muñones

Repara cerámicas

Caries de cuello (evita que “salten”)

1 a 83€ - 2 a 79 € - 4 a 72 €

<https://www.youtube.com/watch?v=uWq5hpQPvJ8&t=4s>



Ver video



KIT COMPOSITE SELECCION



Anterior - posterior

- Fácil manejo
- Gran estética
- Máxima dureza
- Garantía de calidad

4 composites de 4 gr
1 adhesivo bond 5 ml
1 jeringa de ácido 2,5 ml

Color a elegir: A1- A2 – A3 – A3,5 – A4
incluido fluidos

~~PVP 175 €~~

OFERTA 144 €

GRATIS

**Una caja de 6 fresas para cavidades
a elegir**



VITTRA UNIQUE

Composite camaleónico, para todos los colores



Diastema

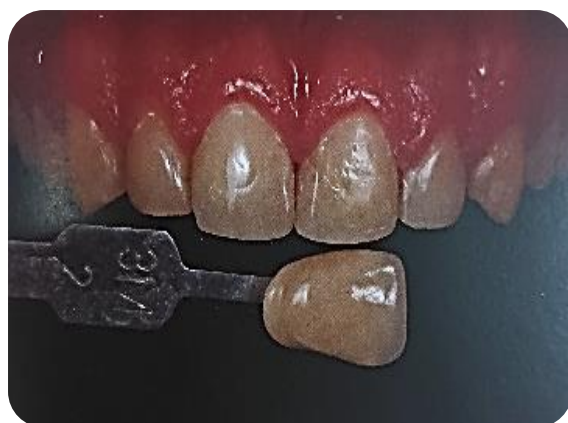

Cierre



Blanqueamiento

Evita retirar el composite en caso de blanqueamiento posterior

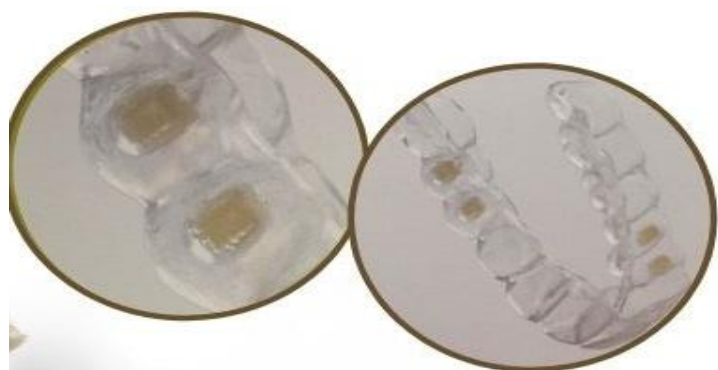

En attaches, se mimetiza con la pieza

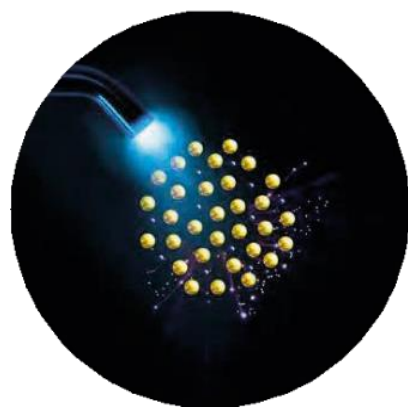
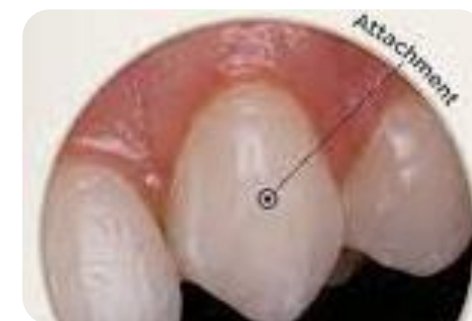

La canforoquinona amarillea el composite



No cambia el color de las carillas



No amarillea al polimerizar

Fluorescencia natural NO BIS GMA

Jeringa de 4 gr **54,10 €**

Jeringa 2gr.

3+2 GRATIS

31,78€

20 cápsulas **54,10€**

3 + 2 gratis





ADHESIVO AMBAR APS



6 ml

El único que no amarillea

Ideal con humedad,
próxima a encía y dentina



No cambia el color
de las carillas



Para todos los composites

Sale una gota,
no echa de más



Adhesión más
duradera

No afecta al color del bracket cerámico

390 gotas 55,11 €

+ 6 jerin. ácido fosforic. 37 % gratis





ADHESIVO AMBAR APS UNIVERSAL



5 ml

Grabado ácido total y
**autograbante en esmalte
y dentina**

El único que no amarillea

Ideal con humedad,
próxima a encía y dentina

Para todos los composites

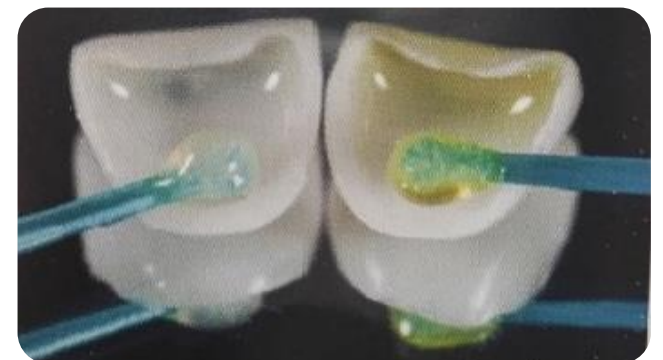

**No cambia el color
de las carillas**



Adhesión más
duradera



**Sale una gota,
no echa de más**

~~PVP 76,19 €~~

OFERTA 66,29 €

MAS 1 Vittra Unique 2 gr.

Gratis



GLASS LINER

Ionómero fotopolimerizable



Jeringa de 2 ml. con puntas

Resistencia
(200 mpa.)

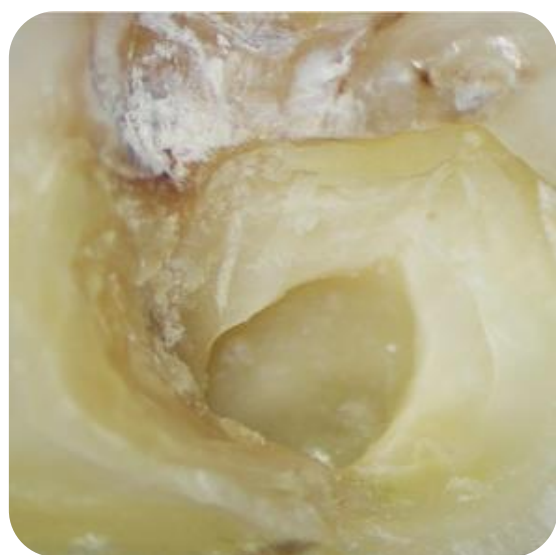

Ideal para obturación de cavidades irregulares y/o profundas, sin atacar



Caries profundas

- **Evita segundas visitas por dolor**
- Rápido: una capa de hasta **5 mm.** y lámpara
- **Base y relleno de cavidades,** debajo de composites, etc...
- Ahorra materiales, tiempo y costes, mejorando el resultado

1ud. a 35,70 €

2uds. a 32,70€/ud

4 a **30,50 €/ud**

PEROXILL (polvo enzimático)

Desincrusta, desinfecta y esteriliza al tiempo

✓ **Evita los riesgos de manipulación**



✓ Desintegra restos orgánicos (sangre, dentina...llegando a zonas inaccesibles)

✓ No afecta a instrumentos de corte

✓ Puede meter cualquier material (limas, gafas, bolígrafos...)

✓ Al hacerlo en frío, puede reducir la temperatura del autoclave, alargando la vida del instrumental

✓ No es volátil, cambiar en función de la carga

✓ Saca el doble o triple de rendimiento



1000 gramos

1 ud 52 €

2 uds 49 € / unidad

Ver

video



<https://www.youtube.com/watch?v=oooafk6bb1k&t=27s>



ADAPTADOR DE CÁNULAS QUIRÚRGICAS DE 11 mm A MANGUERAS DE 16 mm



Esterilizables

5,50 € / unidad

ADAPTADOR ASPIRASALIVA DE 6 A 11 mm



Esterilizables

19,50 € Caja de 5 unidades

INDICADOR BIOLÓGICO



10 ampollas **27 €**

BOLSAS AUTOSELLANTES

200 unidades



Poner en autoclave plástico con plástico

5 x 25 cm **9,50 €**

9 x 23 cm **11,60 €**

7,5 x 25 cm **11,60 €**

5,7 x 10,50 cm **7,90 €**

13,5 x 25,5 cm **17,90 €**

Otras medidas, consultar

ROLLOS ESTERILIZAR



5 cm x 200 m **14 €**

7,5 cm x 200 m **19,50 €**

10 cm X 200 m **25,50 €**

15 cm X 200 m **43,90 €**

20 cm x 200 m **55,90 €**

25 cm x 200 m **80,90 €**



10

BIOCOLLAGEN MEMBRANA DE COLÁGENO



REF: 0012 1 MEMBRANA DE
25X25X0,2 mm

97 €

REGENERACIÓN GUIADA EN COLÁGENO
DE TENDÓN DE AQUILES NATURAL DE
UNA SOLA PIEZA (NO "PARCHES")

MÁS TIEMPO DE PROTECCIÓN DE INJERTOS ÓSEOS

TIEMPOS DE PROTECCIÓN 4-6 SEMANAS

FLEX LÁMINA FLEXIBLE CORTICAL Y ESPONJOSA



AUMENTO VERTICAL
Y HORIZONTAL DE
LA CRESTA Y
AREDES DEL HUESO



FÁCIL COLOCACIÓN Y
MANTENIMIENTO

AL SER FLEXIBLE PUEDE
CONTORNEAR EL DEFECTO

REF:0029 ESPONJOSA
25 X 25 X 3 mm

201 €

TIEMPO DE REMODELACIÓN

4-6 MESES (ESPONJOSA)

REF:0030 CORTICAL
25 X 25 X 2-2,5 mm

201 €

8-12 MESES (CORTICAL)



XENOMÁTRIX GENERAL MATRIZ PARA REGENERACION DE TEJIDOS BLANDOS

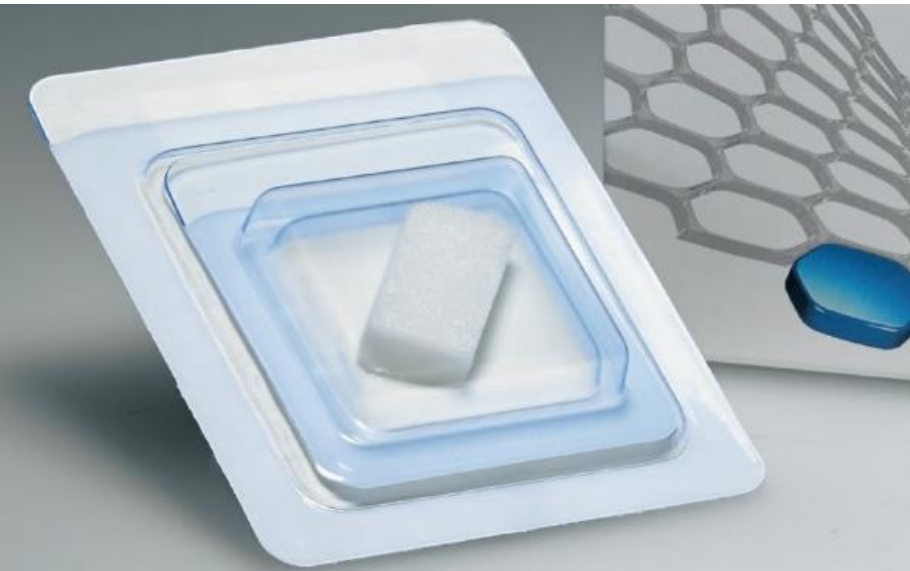

REF: 0015 15X30X4 mm

132 € 1 UNI

TENDÓN DE AQUILES ORIGEN EQUINO

ACELERA LA CICATRIZACIÓN
(NO ES PROTECCIÓN DEL INJERTO)

DISMINUYE INFECCIONES

MEJOR RESULTADO ESTÉTICO



RECESIÓN
GINGIVAL



PULIR LA RAÍZ
EXPUESTA



IMPRESINDIBLE LOGRAR EL
POSICIONAMIENTO PASIVO



POSICIONAR LA MATRIZ
Y SUTURAR CON
PUNTOS
REABSORBIBLES



SUTURAS
INTERRUMPIDAS Y EN
CABESTRILLO, LIBRES DE
TENSIÓN



A LOS 4 MESES CON
COBERTURA RADICULAR
Y **GROSOR**
ADECUADO

EVITA 2ª CIRUGIA E INJERTOS DE PALATINO



10

XENOMÁTRIX ALVEOLAR

MATRIZ PARA REGENERACION DE TEJIDOS BLANDOS

REF: 0016A 20X10X4 mm REF: 0016B DIAM. 14X4mm

2 UNI

132 €



XENOMATRIX

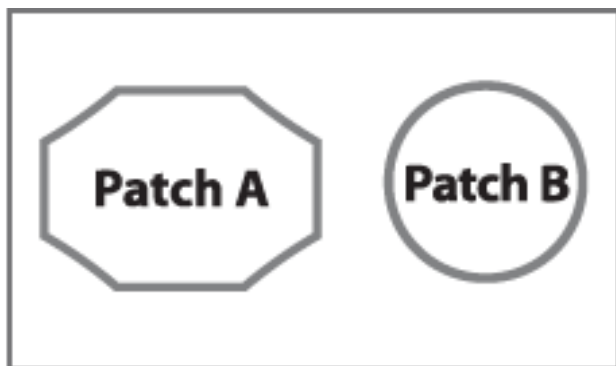

2 PARCHES A y B

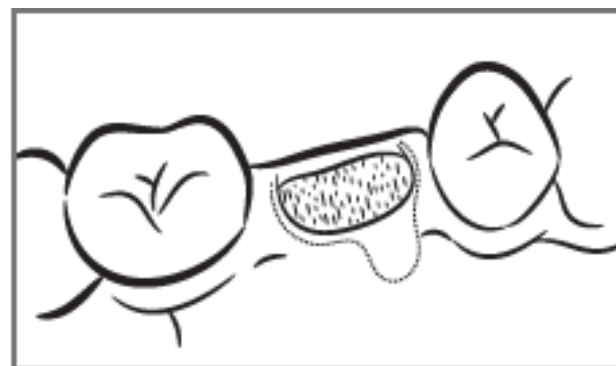

ALVEOLO POST-EXTRACCION

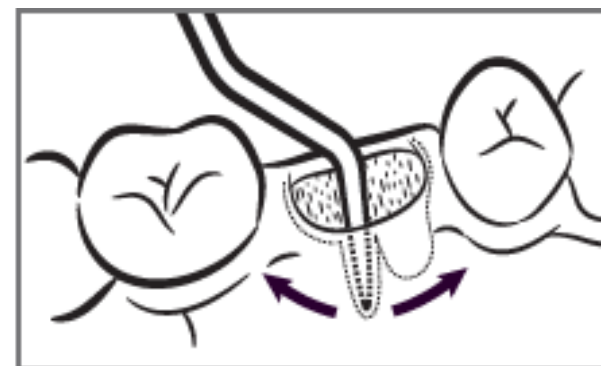

SEPARE EL PERIOSTIO ALREDEDOR DEL ALVEOLO



PONER LOS GRÁNULOS

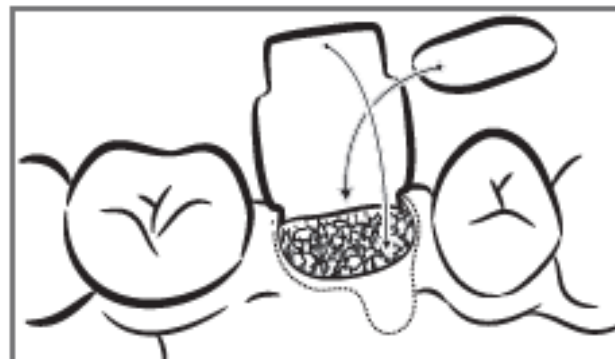

ZONA CORTA DEL PARCHE "A" DEBAJO DE LA SOLAPA PARCHES "B" SOBRE INJERTO

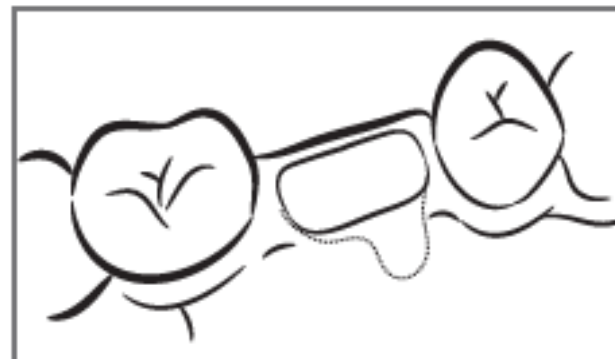

LA OTRA PARTE DEL PARCHES "A" DEBAJO DE LA SOLAPA CUBRIENDO EL PARCHES "B"



PUNTOS EN CRUZ



ALVEOLO POST-EXTRACCION



HACER "BOLSILLO" EN AMBAS CARAS



IMPLANTE INMEDIATO CON INJERTO ÓSEO Y PARCHES



EXPUESTA SIN COLGAJO



A LOS 7 DIAS CON TEJIDO



3 MESES



PILAR DEFINITIVO



CORONA DEFINITIVA



10

MEMBRANA DE PERICARDIO EQUINO

REF: 0040 15X20X0,2 mm 2 UNI **201 €**

RECUBRIMIENTO DE INJERTO
ÓSEO DE LARGA DURACIÓN
3-4 MESES CON PROTECCIÓN
EPITELIAL

RESISTENTE Y ELÁSTICA

EFFECTO BARRERA DURADERO

FÁCIL MANEJO Y SUTURABLE

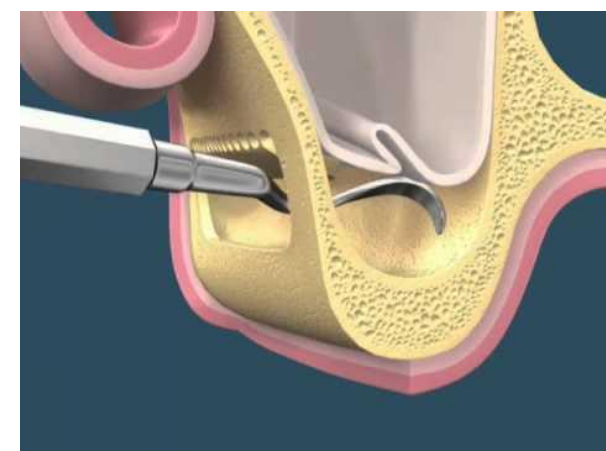

ELEVACIÓN DE SENOS
MÁS TIEMPO DE
PROTECCIÓN



FIJACIÓN CON
TORNILLO DE
OSTEOSÍNTESIS



ESPACIO CORTICAL
RELLENO DE
GRÁNULOS

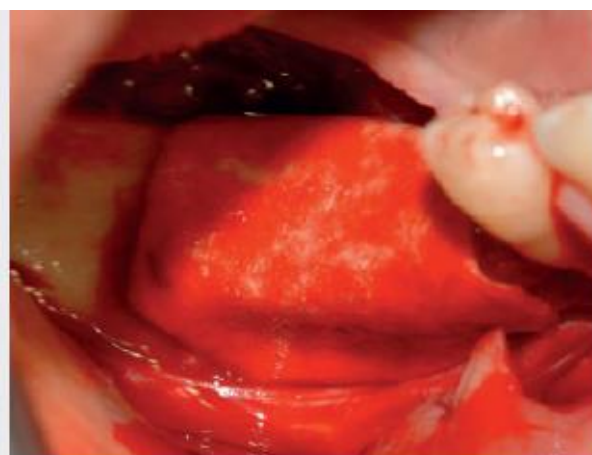

CUBRIR EL INJERTO
CON LA MEMBRANA
DE PERICARDIO



APERTURA 5 MESES
DESPUÉS

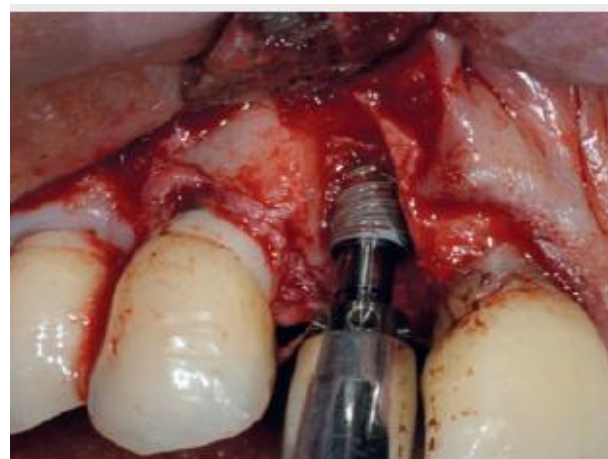

CAVIDAD SIN PARED
VESTIBULAR

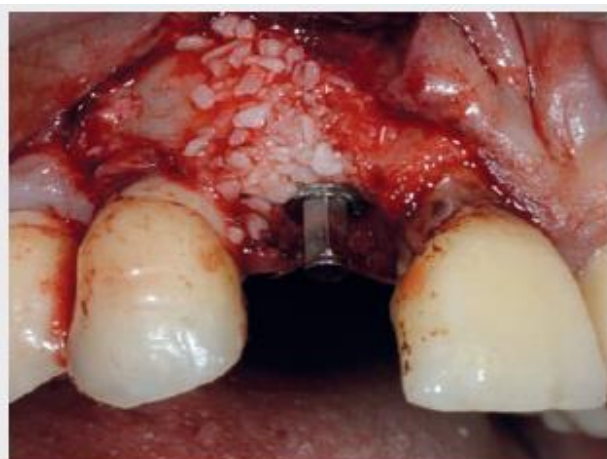

RELLENAR DEFECTO
CON GRÁNULOS

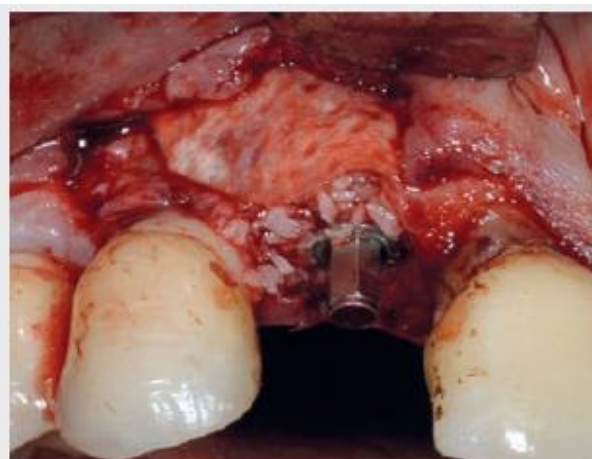

CUBRIR CON
MEMBRANA DE
PERICARDIO



CICATRIZACIÓN A LOS
7 MESES CON
VOLUMEN PAPILAR